

Materials for 1 Solar Cork Boat
or 1–3 Students

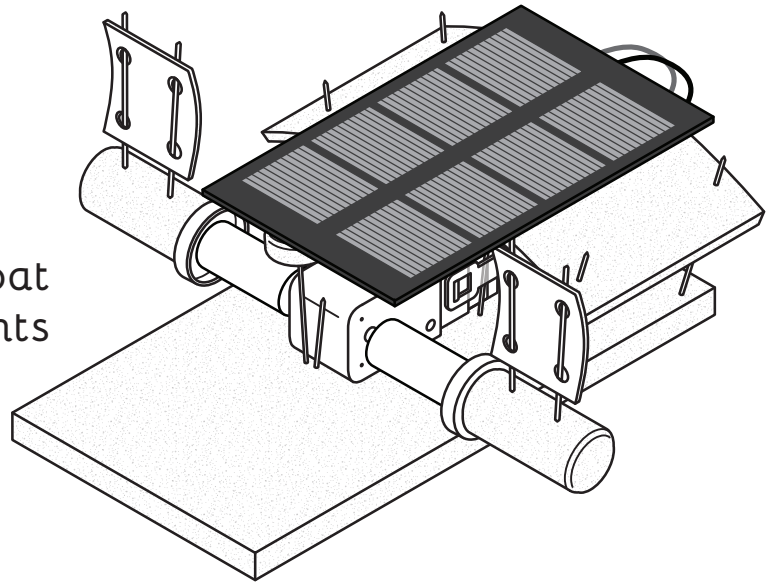

Grades

- 4–12

Concepts

- Inquiry and science process
- Energy and energy transfer
- Mechanical and Electrical work
- Basic circuitry
- Buoyancy
- Propulsion, drag, and load
- Using basic tools
- Collecting and interpreting qualitative data

Time required

- Two or three 45 minute class periods

Objectives

At the end of the lesson, students will:

- Understand and be comfortable with basic electrical concepts and terminology
- Know the fundamental aspects of a solar panel and understand how placement and orientation affect its power output
- Be able to design a propulsion system of propellers or paddles
- Design functional solar boats that can carry the most weight

Your REcharge Labs Classroom Kit

The materials enclosed in this kit will help you bring engaging lessons about renewable energy into your classroom. Consider attending a REcharge Training, if you haven't already done so, to enhance your experience using these materials.

About REcharge Labs

We believe that responsible and informed students of today will become our innovative renewable energy leaders of tomorrow. At REcharge Labs, our mission is to provide the resources to encourage this generation of informed thinkers, involved doers, and curious life-long learners.

REcharge Labs provide everything you need to teach renewable energy.

- Professional development workshops that prepare you to teach fun, hands-on project-based wind and solar activities.
- Scalable activities for different age groups and time frames.
- Kits and resources that fit educational standards and your budget.

We recommend attending a REcharge Lab training workshop to enhance your experience using these kits.

REcharge Labs was born out of programming from the KidWind Project, and relies upon KidWind's resources and history to carry out its work. KidWind has been a leader in renewable energy education for over a decade. REcharge Labs, like KidWind, continues to be committed to bringing affordable, hands-on applications of our materials to teachers and students worldwide.

A note on reproduction

Reproduction of this activity guide and associated kit is prohibited except for student use in the classroom. For permission to copy portions or all of this material for other purposes, please contact REcharge Labs at info@rechargelabs.org.

Find kits and sign up for training workshops at www.rechargelabs.org



Materials

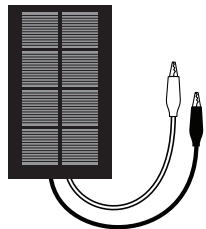

Solar panel
(2V 400mA)

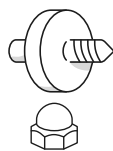

Screw hubs
w/ acorn nuts



Corks w/
holes

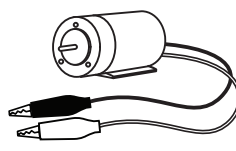

Waterproof
Solar Motor

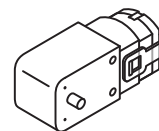

48:1 double
shaft motor

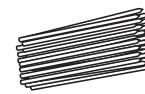

Bunch of
toothpicks

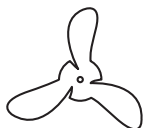

Propellers
(2 and 3 blades)

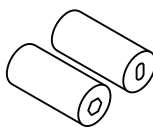

Motor Key
Adapters

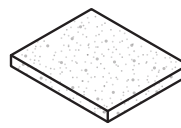

1/4" x 6" x 6"
cork sheet

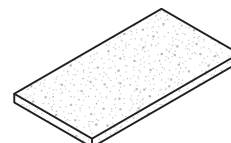

1/2" 3" x 6"
cork board

You will need to supply the following materials:

- Towels or rags for water spills
- Water
- Paper and pencils
- Scissors
- Weights of similar size and weight, for example: marbles, pennies, or washers. If marbles are the only readily available weight, have some sealable sandwich bags handy to put them in.
- If doing project indoors, you'll need an adjustable table lamp rated for 150 watt or higher incandescent bulb and a 150 watt or higher incandescent bulb.
- Water container to float the boats, for example: outside pool, wash tub, or under bed storage container, at least one foot deep and two feet across. If using a container, fill with at least 8" of water and make sure it is placed outdoors in full sun. If using a pool, choose a location without shadows. If indoors, ensure that water spills will not cause slipping, touch wall power or any power cords, or result in property damage.
- Print out of the Solar Cork Boat worksheet (page 15)

Bonus materials to supply:

- Recycled materials for boat making like paper or Styrofoam drinking cups, plastic cups, spoons, and packing Styrofoam.
- Rubber bands of different sizes

Background

Paddles are one of the most important ways humans have discovered to propel boats. Some of the earliest evidence of paddles were found alongside canoes in the Netherlands, estimated to have been constructed between 8200 and 7600 BC. Before motorized boats, people all over the world built canoes and used paddles to move and steer them; Australian Aboriginals, indigenous peoples of the Americas, and later European immigrants to the Americas. Even with the invention of steam power and stronger engines, the role of the paddle was not lost. Because of the paddle's dexterity moving through shallow water and paddling upstream, Mississippi river boats were all outfitted with huge paddle wheels. Today, paddles are still stored in motorboats and sailboats in case fuel runs out or the wind dies down.

Learning Goals

Students will engineer custom paddles and propellers and use the solar power to create a boat that can move in the sun. Students will learn about buoyancy, balance, and drag as they design their boat. They will explore in depth how solar power turns radiant energy into electrical energy, then into mechanical energy. Students will learn the variables that affect solar panels and the factors that influence the performance of paddles and propellers, ultimately building a solar boat that can transport the most weight.

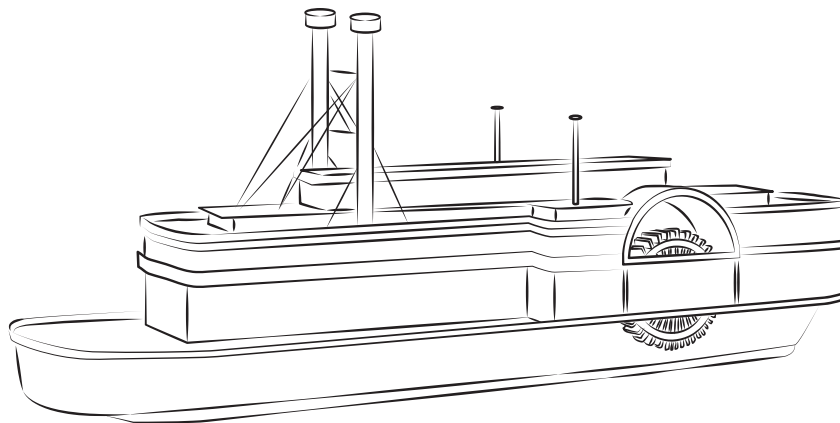

Getting Ready

- Build and test your own Solar Cork Boat before the class begins. This is a valuable preview to the challenges and problems that students will face. Your example will also help students conceptualize the final product of the lesson.
- Brush up on your circuitry knowledge, as students will have questions.
- Gather the tools and any additional items students will need to complete the activity.
- The main parts of this activity are best done outside on a sunny day, although if necessary, they can be done indoors using other light sources. If outside is not an option, make sure you set up high wattage lamps in the activity area, with at least 150 watt incandescent bulbs. For best performance indoors, lamp lights need to be 4"-10" from the solar panel. **Warning: lamps set up by water is very dangerous. Please secure so that there is no chance any part of the lamps will touch or be bumped into the water.**
- For day one, find some examples of unusual boats, solar boats, and paddle wheel boats.

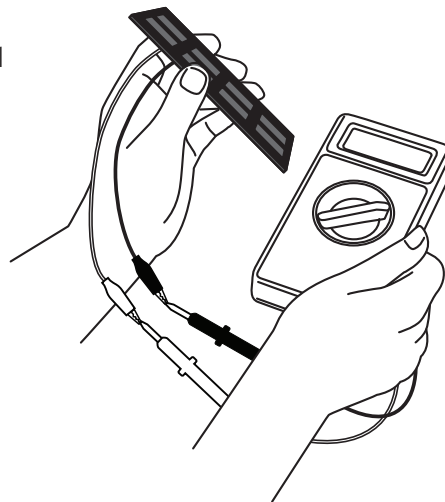
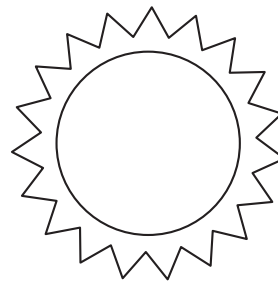

Activity Overview

This is a step-by-step activity guide that will take two 45 minute class periods to complete.

Class Period 1: Understanding mechanical and electrical work, and testing solar panel variables. Working in groups to design Solar Cork Boat prototypes that can accomplish the Engineering Design Challenge: propel forward as straight as possible using solar power, and transport as much weight as possible.

Class Period 2: Continue work time, testing, redesigning, and testing again.

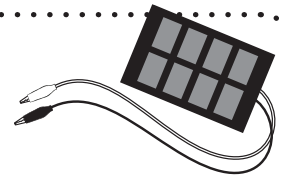

CLASS PERIOD 1

Understanding mechanical and electrical work, testing solar panel variables, and designing boats for the Engineering Design Challenge.

Step 1: Activity agenda and examples

Introduce the project to the students. Show the example of your solar cork boat. Talk about your inspiration for the boat, and demonstrate how it works. Next, show examples of unusual boats, solar boats, and paddle wheel boats. Discuss with the students the examples and the function of some of the features of the boats.

Step 2: Beginning questions for students

- Name the light sources that are around you right now. What are some of the qualities of the different light sources?
- Have you seen a solar panel before? How do you think a solar panel works?
- What variables do you think affect how much energy the solar panel produces?

- How does the time of day effect how a solar panel works?
- Have you ever seen or been on a paddle wheel boat? How is it different from other boats?
- How can a solar panel be useful on a boat?

Step 3: Distribute materials

Organize students into groups of 1-3. Each group will need: three pieces of paper, pencils, one 48:1 double shaft motor, one waterproof motor, two propellers, two screw hubs, two Motor Key Adapters, some toothpicks, one piece of 1/2" cork board, two bottle corks, and scissors.

Step 4: Identify parts and assemble them

In groups, have students take turns looking at the objects and trying to identify them and their potential uses. Below are descriptions of the objects to help, along with assembly instructions where applicable.

Solar panel: The correct term for this item is PV (photovoltaic) module, but because it's common

name is solar panel, that is the term used in the guidebook. A solar panel is made up of tiny photovoltaic (PV) cells. Photovoltaic comes from the words photo, meaning light, and volt, the measurement of electricity. Solar panels transform radiant energy (light) into electrical energy, which can be used to power a motor. Because solar panels require light to generate electricity, the intensity and the angle of the light affects how much electricity can be generated. Features: There are two wires, one red (+) and one black (-) attached to the panel by screws, with clamps on the opposite ends. Solar panels are a direct current (DC) circuit, meaning one pole is always negative, the other pole is always positive, and the electrons only flow in the direction of negative to positive (Fig.A).

Load: A load is work the power source has to do. Included in the kit are two types of motors, which can act as a load on the solar panel. Some loads are more difficult to power than others. Think

Fig. A

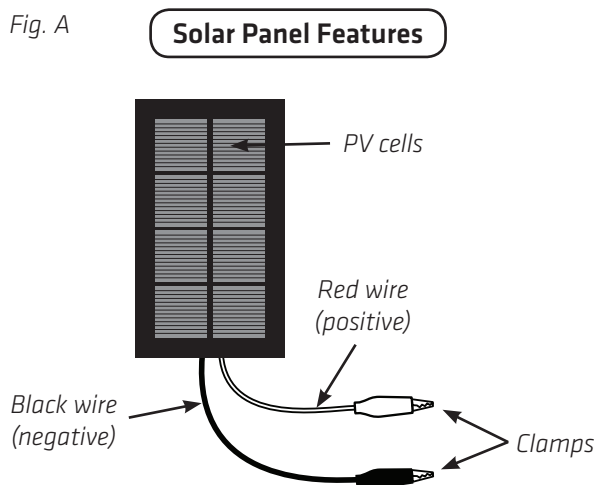

of the loads as weights. Some may be easy to lift because they are light, and some may more difficult to lift because they are heavy. In order to lift heavy loads with a solar panel, more electricity needs to be generated by using a stronger light source, connecting additional solar panels, or reducing the load.

Waterproof Solar Motor: A motor transforms electrical energy (from the solar panel) into mechanical energy to spin a shaft. Features: this motor is a DC circuit, and has a red (+) and black (-) wire. The motor can be submerged in water, attached to the bottom or the side of the boat.

Assemble waterproof motor propeller: Push one of the propellers onto the waterproof motor shaft, then set aside for now (Fig. B).

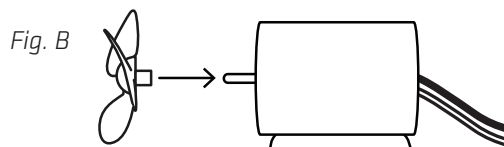
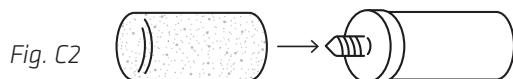
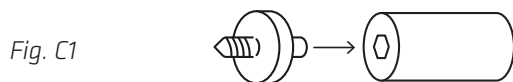

Fig. B

Geared motor: A geared motor transforms electrical energy into mechanical energy to spin a shaft, with the addition of mechanical gears to increase torque and reduce speed. Torque, sometimes referred to as “pulling power,” is the amount of force required to twist an object. Features: this motor is geared down to a 48:1 gear ratio. The gear ratio means whenever the metal motor shaft spins once, the plastic arms spin 48 times slower, adding more torque. This is useful because a motor with more torque can pull more weight, although it will do so at a slower speed than a regular motor. This geared motor is a DC circuit, and has a red (+) and black (-) wire.

Assemble geared motor adaptors: Push the Motor Key Adapters onto each white plastic motor shaft arm by following the illustrated instructions. Snap in the Screw Hubs on the end of each Motor Key Adapter (Fig. C1). Next, take the corks, and screw one into each Screw Hub until tight (Fig. C2 and Fig. C3). Just to demonstrate, pull off one of the Screw Hubs with an attached cork, and notice how it can fit on the metal motor shaft, as well as the waterproof motor shaft. Place the Screw Hub with cork back onto the Motor Key Adapter.

Step 5: Make the cork hub



Toothpicks can be used to poke into the corks on the geared motor (Fig. D). The cork is now a hub and the toothpicks are spokes which can hold onto paddles or propeller blades. The shape, material, and number of paddles or propellers will directly affect how much the boat moves in the water.

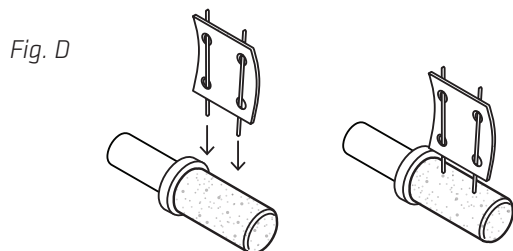

Step 6: Attach the geared motor to the 1/2" cork board

Situate the geared motor somewhere on the 1/2" cork board, and following the illustration, push toothpicks into the plastic side bands to secure the geared motor to the cork board (Fig. E). Rubber bands, string, and tape can also be used.

Step 7: Test solar panel variables

While in groups, have the students attach the solar panel to one of the motors, and go in the sun (or under a lamp) to test and see what factors produce the best performance from the solar panels. Make sure they have both motors available and switch them out to see if there is a difference.

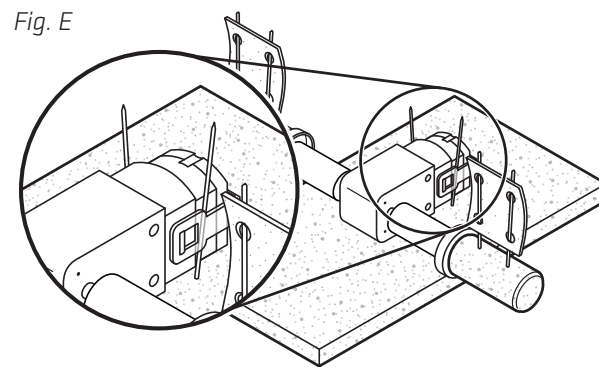

Variables to be tested:

- Angle of solar panel to the light source
- Type of motor attached
- Time of day if in the sun, or type of bulb and wattage if using lamps

As students are testing their solar panels with

different variables, watch what they are figuring out. There may be some troubleshooting you can help with, refer to the tips below.

TROUBLESHOOTING THE SOLAR PANEL:

- Check the connections between the solar panel and motor, and make sure they are attached properly.
- Make sure the solar panel is directly facing the light source, and there are no shadows or objects (including fingers!) blocking the panel.
- Move the solar panel closer to the light. Be aware that if you are too close to a hot lamp, you may burn yourself or the panel.
- The light source may not be strong enough, move on to test different kind.
- If the solar panel is left under a lamp and gets hot, it's ability to produce electricity will be significantly less than in it's room temperature condition. Cool the panel off and its production should return to normal.
- Check the wire terminals on the back of the solar panel. Where the wires are screwed into the panel, make sure the wires are still secure. If they have fallen out, screw them back in. If the wire has been broken off, use a wire stripper to strip off ¼" of the wire, twist the copper threads, and screw in the wire to the terminal.
- Make sure there are no short circuits. A short circuit is an important safety issue to bring up with students. It is easy to prevent, but a short circuit will probably happen at least once during the activity. A short circuit occurs when two conductive parts are touching

within a circuit, causing a path of very low resistance (Fig. F). When a short circuit occurs, the load stops working, and the power source will start to get hot! Unlike a battery pack-which can get dangerously hot instantly, the small solar panel provided takes a while to get hot in a short circuit, and is not as dangerous. Regardless, short circuits still need to be watched out for and prevented.

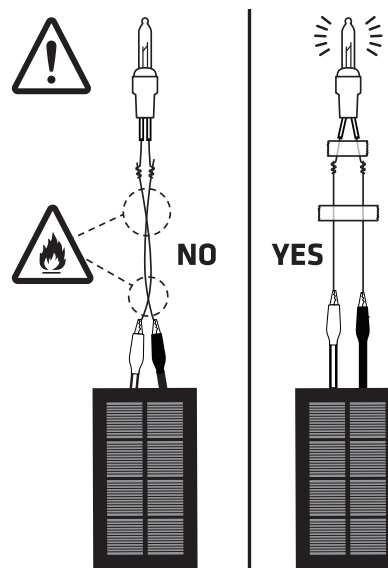

Fig. F

Step 8: Introduce the Engineering Design Challenge

The Solar Boat must accomplish two things:

1. Propel forward as straight as possible using solar power
2. Transport as much weight as possible

Any of the supplies distributed earlier can be used. If extra supplies are available, notify students of quantities they can get of each item.

Step 9: Group brainstorming

Before building the first test boat, give the groups some time to come up with at least three different designs, sketching them on paper. These are just sketches of ideas, not to be taken as final, and are meant to encourage the collaboration process.

Step 10: Work time and documentation of design changes

Have the students focus on getting their designs on paper and building their first prototypes. Remind them to keep track of any changes they make to their design, and any solar panel variables they find to work best for them.

Step 11: Keep track of results

Make copies of the Solar Cork Boat Worksheet on page 15 and have students fill it out during their testing process. To do the sheets as a class, draw a chart on the board showing group names, test trial number, redesign issue addressed, distance, and weights transported. Whenever a test has been made, have the groups write down their results and design changes.

Step 12: Clean up

Label design plans with a group name, and place what they are working on and all their supplies on top. Store the project until next class period. Clean up the workspaces, and any water spills that might have occurred.

Optional reading for homework

Understanding how a solar panel produces electricity is important in knowing why it works! Have students do the brief reading on page 15 or find additional resources that will help them understand.





CLASS PERIOD 2:

Continue work time, testing, redesigning, and testing again.

Step 1: Activity agenda

The first part of class will be focused on group work time in order to complete the design challenges, and recording test results. The last part of class will be a show and tell of group work, and a discussion about the Solar Cork Boat Worksheet.

Step 2: Test, redesign, and record (30 minutes)

Have students go back into their original groups, and gather their supplies and projects from Class Period 1. Remind them to continue to record any changes they make in their design, and to take notes within their prototype sketches. This documentation will be helpful during their group presentations.

Step 3: Group presentations (10 minutes)

Have groups go around and very briefly talk about their most successful Solar Cork Boat, and the design choices they made to get there. What did they discover, and what were their triumphs and challenges? Take pictures!

Step 4: Clean up and break down (5 minutes)

Clean up the room, organize the supplies, and wipe up any water spills. If the Solar Cork Boat parts are to be used again, have the students take

their boats apart, and place the parts on a towel to dry. The cork, like the circuitry parts, can be used repeatedly. If the geared motor has gotten wet, which is likely, just place on a towel to dry out completely. Next time the geared motor is used, before it is distributed to students, “unstuck” the gears by using a Motor Key Adapter on the plastic shaft manually cranking back and forth.

Extension Activity

Adding motors in series or parallel, and building larger boats.

This extension is useful for students who are ahead of the activity, or if additional class time is available.

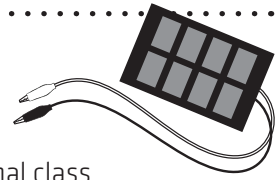

Adding the geared and the waterproof motor in series

Follow the illustration to wire the two types of motors in series with the solar panel. You will notice, depending on the order, one motor will take the available power from the solar panel first, and give whatever is left over to the next motor in line.

Wired in series

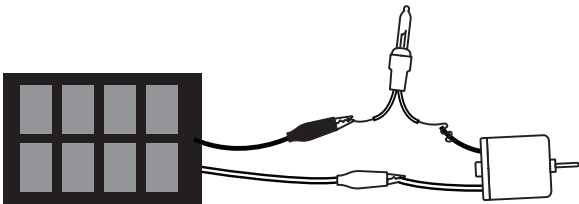

Adding the geared and the waterproof motor in parallel

The illustration below details how to hook the two types of motors in parallel. In parallel, the motors are getting the power from the solar panel at the same time.

Wired in parallel

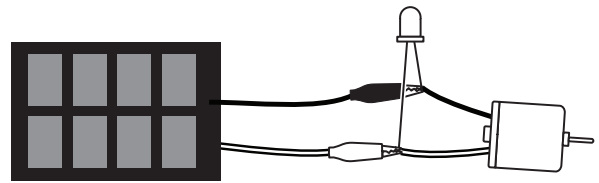

Building bigger and better boats

More can always be added to improve the solar boat design. With additional time, students can add detail and research ways to improve their design.

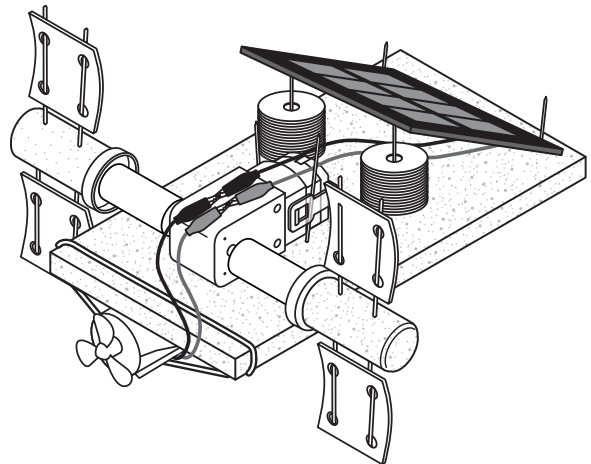

Vocabulary

We have listed some important vocabulary terms for students to understand as they work through the activities.

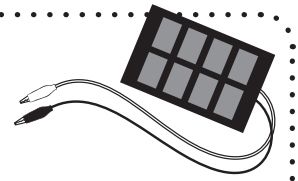

direct current (DC) circuit

A circuit in which one pole is always negative, the other pole is always positive, and the electrons flow from negative to positive.

load

The work the power source (solar panel) has to do.

parallel circuit

A circuit in which components are connected in parallel lines, like tracks on a railroad line. In parallel, current changes and voltage remains consistent throughout.

series circuit

A circuit in which components are connected in a single path, like hands being held. In series, voltage changes and current remains consistent throughout.

short circuit

Occurs when two conductive parts are touching within a circuit, causing a path of very low resistance.

solar panel

Or PV (photovoltaic) module. The term comes from the words photo, meaning light, and volt, the measurement of electricity. Solar panels transform radiant energy (light) into electrical energy.

torque

Sometimes referred to as “pulling power,” is the amount of force required to twist an object

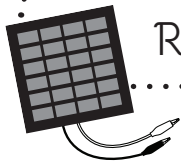

Reading: How Does a Solar Panel Work?

Given how prevalent solar panels are, it's surprising how little most people understand them. Give your students a brief overview of the process that happens inside each solar panel. Find a video or a diagram to supplement, this will give them a more tangible understanding of how this can be used as an energy source.

Each solar panel is made up of tiny photovoltaic (PV) cells. Photovoltaic comes from the words photo, meaning light, and volt, the measurement of electricity. They convert light directly into electricity. PV technology works any time the sun is shining, but the most electricity is produced when the light is intense and when sunlight is striking the PV modules at a perpendicular angle, which is the most direct.

Sunlight is composed of photons, or bundles of radiant energy. When photons strike a PV cell, a fraction of them are absorbed, and the energy from these photons is transferred to electrons in the atoms of the solar cell. With their newfound energy, the electrons are able to escape from their normal positions associated with their atoms to become part of the current in an electrical circuit. By leaving their positions, the electrons cause holes to form in the atomic structure of the cell into which other electrons can move, continuing the process.

Solar cells are usually made of two thin pieces of silicon, a semiconductor. One piece of silicon

has a small amount of boron added to it, which gives it a tendency to attract electrons. It is called the P-Layer because of its positive tendency. The other piece of silicon has a small amount of phosphorous added to it, giving it an excess

- ⊕ Protein
- ⊖ Tightly-held electron
- Free electron
- Can accept an electron

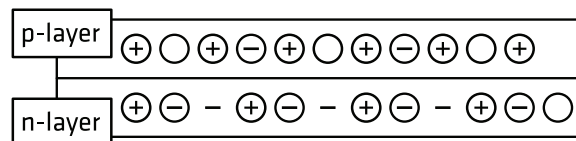

PHOTOVOLTAIC CELL CROSS SECTION

of free electrons. This is called the N-Layer because it has a tendency to give up negatively charged electrons. When the two pieces of silicon are placed together, some electrons from the N-Layer flow to the P-Layer and an electric field forms between the layers. The P-Layer now has a negative charge and the N-Layer has a positive charge. When the PV cell is placed in the sun, the radiant energy energizes the free electrons. A circuit is made connecting the layers, forcing electrons to flow from the N-Layer through the wire to the P-Layer. The flow of electrons means the PV cell is now producing electricity!

Solar Cork Boat Worksheet

TEST TRIAL NUMBER	MODIFICATION	DISTANCE PROPELLED	WEIGHTS TRANSPORTED
1			
2			
3			
4			
5			
6			
7			
8			
9			
10			
11			
12			
13			
14			
15			



Did you like the **Solar Cork Boat Kit**? Then you might be interested in these REcharge Labs classroom kits.

Mini Windmills Class Pack

Use a limited amount of materials to design and build functioning windmills that lift weight. This kit is ideal for younger students, and is a simplified version of the MacGyver Windmill Class Pack.

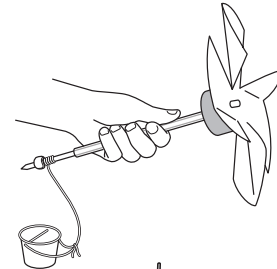

Sail Car Class Pack

Build a Sail Car using inexpensive materials to demonstrate how wind can be used to propel an object. Gather measurements, record changes in variables, and use simple engineering design concepts to build sails that can push the car as far as possible.

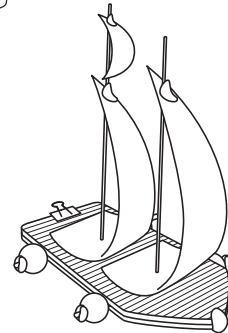

Solar Fountain Kit

Learn how to use the power of the sun to build a creative electrical fountain. Discover how solar panels work, learn basic circuitry, and use this knowledge to build a custom solar powered fountain.

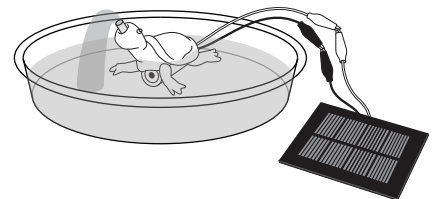

Visit www.rechargelabs.org for more.

2010 E Hennepin Ave, Building 2, Suite 101, Box 51, Minneapolis, MN 55413
Phone: 877-917-0079 | Fax: 208-485-9419 | Email: info@rechargelabs.org

© REcharge Labs 2016 All Rights Reserved